

Alpine STRUCTURES

Restructure
your backyard!



1.800.359.7522



Built On-Site &
Pre-Built Structures



Not all buildings are created equal.

It all started one winter many years ago, in a small shop where our first storage barns were built. By the end of the year, our founder, Mose Miller, realized the need for storage buildings, and in 1981 Alpine Structures was born. As we continue to grow, Alpine Structures remains dedicated to providing high-quality products with excellent customer service. Our success is credited first and foremost to God who has blessed us abundantly with wonderful employees and loyal customers.

Javan Miller, owner



The Difference..... 4
 Door System..... 5
 Strongback Nailer 6

Floor Models 7
 Structure Comparison8-9

Alpine Structures 10-31

Bigger Buildings, Flexible Options



Ez-fit Shed 32-37

Small Sheds With Big Features



2000 Series 38-45

Our Most Economical Structures



Large Structures 46-53

Cabins, Garages & Loft Barns



Site Prep 54
 ProStruct Flooring..... 55
 Siding 56-57
 Roof Options..... 58

Window & Door Options..... 59
 Paint & Stain Options 60-61
 Accessories 62
 Delivery..... 63

quality from the inside out

Aluminum Dripedge...page 4

Metal Truss Plates...page 4

Shingle or Metal Roof...page 58

Primed Trim...page 4

Paint or Stain Colors...page 60-61

Strongback Nailer...page 6

2x4" Framing 16" O.C.

Premium Grade Lumber

4x4" Treated Runners

Choice of three Floor Models...page 7

Siding Options...pages 56-57

Triple-layer door system...page 5



discover the

Alpine difference

Aluminum Dripedge



Added protection against rain, snow, and ice.

Smartside Soffit and Frieze Board



Standard on Cabana, Cove, Frontier, and Skyview. Optional on other styles.

Primed Trim



Standard on all buildings except barnsiding. Decay resistant, primed trim that is ready to face the outdoors.

Metal Truss Plates



Provides superior strength versus wooden gussets.

Double 2x8" top-plate



On Alpine Barnstyles, the rafter is located on outer edge of 2x8" top-plate. Increases wall strength and provides more loft storage.



warranty

We've been here since 1981 and we're committed to continue giving you complete satisfaction.

the triple-layer door system



Spring-loaded barrel bolts.
Included on top and bottom of door.

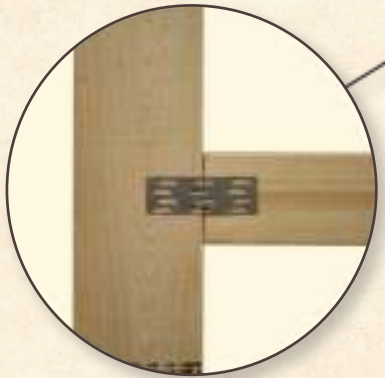

Metal truss plates for superior strength.



Layer #1 – Our 2x3" Door frame is built with premium grade lumber and fastened with a metal truss plate for superior strength.

Layer #2 – LP Smartside Siding that resists warping and cracking, and defies termite damage.

Layer #3 – Decay resistant primed trim that is ready to face the outdoors.



6" Heavy-duty T-hinges with bushings.
Standard on Alpine & 2000 Series.



12" Decorative T-hinges with bushings.
Standard on EZ-Fit Sheds.



Alpine strongback nailer

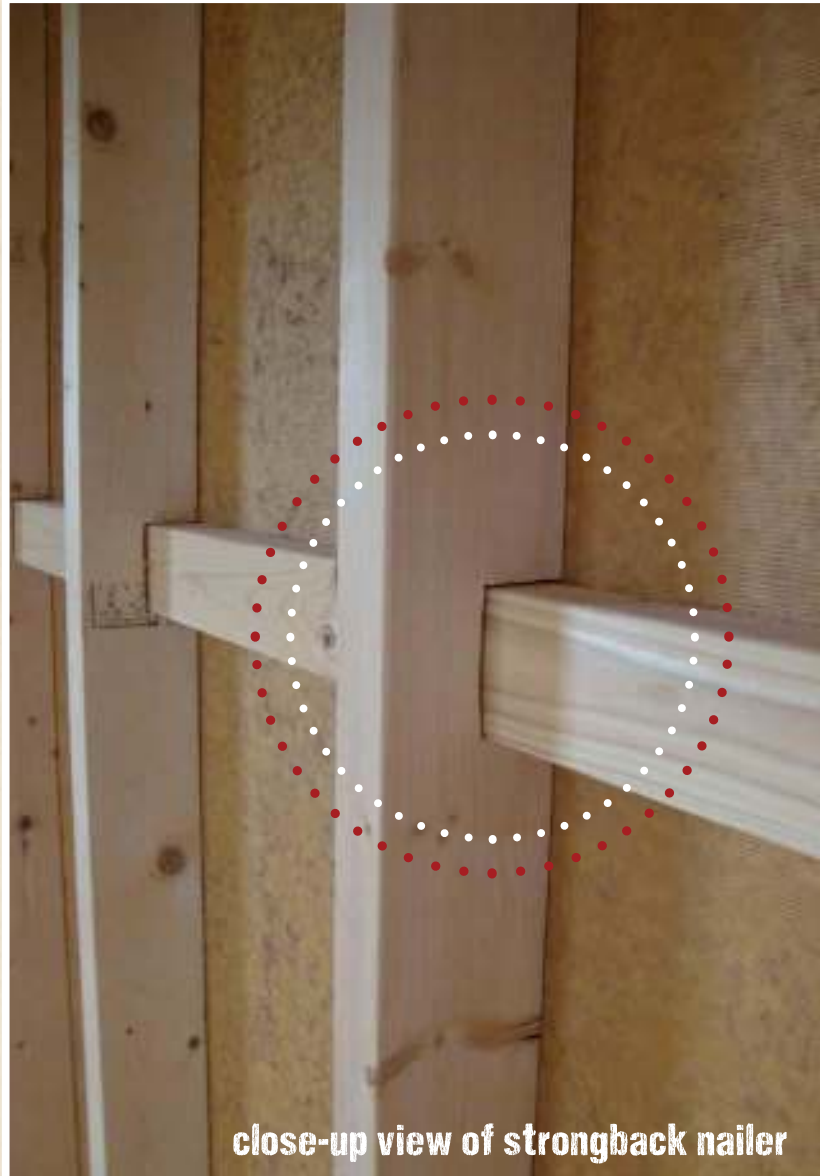

- A STRONGER WALL
- A STRAIGHTER WALL
- INCREASED NAILING SURFACE
- STANDARD ON ALL HIGH SIDEWALLS

.....

Using computerized components saws, each individual wall stud is cut with a specialized notch. We then install our 2x3" Strongback Nailer, creating a *straighter, stronger wall*, and providing *increased nailing surface* for our siding panels.



floor models

Why are the floor joists flat vs. on edge?

Structural Integrity – Flat joists mean more holding power by face-nailing floor joists to 4x4" runners vs. toe-nailing.

Larger support area – Actual distance between floor joists is only 12½"!

Ease of use – Enjoy a minimal step up into your building with this user friendly design.

Standard Model



Floor:
 ¾" CDX Plywood-16" O.C. floor joists
 4x4" treated skids

Walls: 24" O.C. wall studs



Deluxe Model



see page 55

Floor:
 ¾" ProStruct Flooring
 16" O.C. treated floor joists
 4x4" treated skids

Walls: 16" O.C. wall studs



Supreme Model



Floor:
 2x6" Treated Tongue & Groove
 4x4" treated skids

Walls: 16" O.C. wall studs

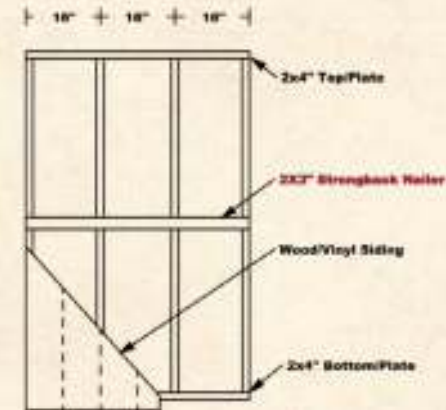
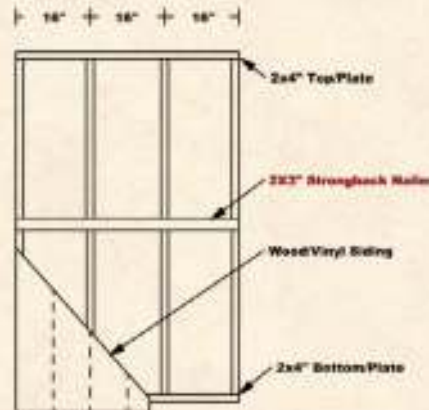
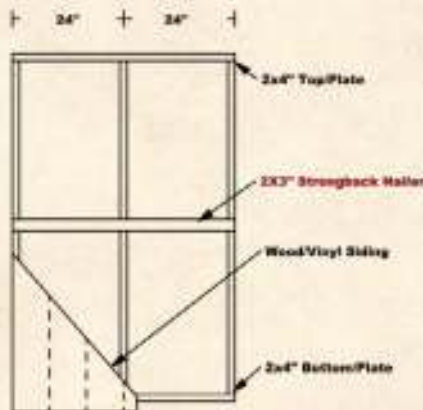

Alpine Structures

Our signature series — the Alpine Structures are bigger buildings, with flexible options. Building sizes start at 8x8' all the way to 16x32' and include special features like a 12" overhang on gable ends and air vents. Careful consideration should be taken when choosing the flooring, the Alpine Structures are available in deluxe and supreme models, for more information see page 7.



Gable 12" O.H. **10**

6'6" Sidewalls
1-24x36" Aluminum window
Bar shutters
52" Double doors
4/12 Pitch roof
2x4" Single top-plate
Sizes: 8x8' – 16x32'



NEW! Cabana **12**

6'6" Sidewalls on 10' and 12'
7' Sidewalls on 8' wide buildings
2-24x47" Aluminum windows
52" Double doors
30" Single door
3 Pitch roof
2x4" Single top-plate
Sizes: 8x12' – 12x24'



Barnstyle 4' **14**

4' Sidewalls
52" Double doors
2x8" Double top-plate
Storage loft B**
Sizes: 8x8' – 14x24'



Barnstyle 6'6" **16**

6'6" Sidewalls
52" Double doors
2x8" Double top-plate
Storage loft B**
Sizes: 8x8' – 16x32'



Barnstyle 4' O.H. **18**

6'6" Sidewalls
52" Double doors
2x8" Double top-plate
Storage loft B**
Sizes: 10x12' – 16x32'



A-Frame 4' **20**

6'6" Sidewalls
1-24x36" Aluminum window
Bar shutters
52" Double doors
30" Single door
12/12 Pitch roof
2x4" Single top-plate
Storage loft B**
Sizes: 10x14' – 16x32'



Cottage **22**

6'6" Sidewalls
1-24x36" Aluminum window
Bar shutters
52" Double doors
30" Single door
6/12 Pitch roof
2x4" Single top-plate
Sizes: 8x12' – 16x32'



Skyview **24**

6'6" Sidewalls
2-24x36" Aluminum windows
Bar shutters
52" Double doors
30" Single door
8/12 Pitch roof
2x4" Single top-plate
Storage loft A*
Sizes: 8x12' – 16x32'



Cove **26**

6'6" Sidewalls
2-24x36" Aluminum windows
Bar shutters
52" Double doors
30" Single door
6/12 Pitch roof
2x4" Double top-plate
Storage loft A*
Sizes: 8x12' – 16x32'



Frontier **28**

6'6" Sidewalls
1-18x27", 1-24x36" alum. windows
Bar Shutters
52" Double doors
30" Single door
12/12 Pitch roof
2x4" Single top-plate
Storage loft A*
Sizes: 10x14' – 16x32'



Gable 42" **30**

6'6" Sidewalls
1-24x36" Aluminum window
Bar Shutters
52" Double doors
2x4" Single top-plate
Sizes: 8x8' – 12x24'



Quaker **31**

6'6" Sidewalls
1-24x36" Aluminum window
Bar shutters
52" Double doors
2x4" Single top-plate
Sizes: 8x8' – 12x24'



see page 7 for flooring options!

A* = 4' loft in buildings up to 10' long, 2-4' lofts in buildings over 10' long.

B** = 2' loft in 8' wide buildings, 4' loft in 10' wides, 2-4' lofts in 12', 14', and 16' wides.

EZ-Fit Sheds

Small Sheds With Big Features

Available with deluxe or supreme floors

Ez-Fit Shed Standard Features

- 6'6" Sidewalls
- "Z" Shutters
- Decorative hinges
- 6/12 Pitch roof
- 6" Fascia
- 2x4" Double top-plate
- Storage loft A*
- Sizes: 8x8' – 12x24'

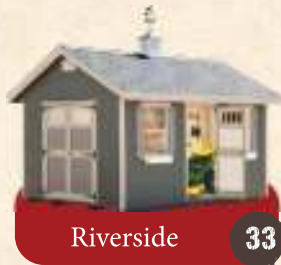

- 60" double doors
- 30" single door
- 2-24x36" windows



- 60" double doors
- 1-30x36" double window



- 60" double doors
- 1-24x36" window
- 1-30x36" window



- 6'6" Sidewalls
- 24x47" Windows, amount varies by size
- 30" Single door with double transom windows
- Decorative hinges
- 6 Pitch roof
- Sun Sky roof
- 2x4" Double top-plate
- 24" wide shelving
- Sizes: 8x8' – 10x16'

2000 Series

Our Most Economical Structures

Available with standard, deluxe, or supreme floors



- 4' Sidewalls
- 52" Double doors
- 2x4" Single top-plate
- Sizes: 8x8' – 12x24'



- 6'6" Sidewalls
- 52" Double doors
- 2x4" Single top-plate
- Sizes: 8x10' – 12x24'



- 6'6" Sidewalls
- 52" Double doors
- 6/12 Pitch roof
- 2x4" Single top-plate
- Sizes: 8x10' – 12x24'



- 6'6" Sidewalls
- 1-24x36" Alum. window
- 8x6'6" Garage door
- 36" Single door
- 2x4" Single top-plate
- 1-4' Loft
- Sizes: 12x16' – 12x28'

Large Structures

Cabins, Garages & Loft Barns

See page 54 for foundation options.



- 8' Sidewalls
- 36" 9-lite entrance door
- 2x8" Double top-plate
- Full loft w/steps
- Sizes: 16x20' – 16x32'



- 8' Sidewalls
- 36" 9-lite entrance door
- 12/12 Pitch roof
- 2x4" Double top-plate
- Full loft w/steps
- Sizes: 16x20' – 24x40'



- 8' Sidewalls
- 36" 9-lite entrance door
- 4/12 Pitch roof
- 2x4" Double top-plate
- Sizes: 20x20' – 30x48'



- 8' Sidewalls
- 36" 9-lite entrance door
- 2x8" Double top-plate
- Full loft w/steps
- Sizes: 20x20' – 24x40'

see page 54 for site prep details!

Restructure your backyard

COMPARISON

Alpine Gable

WITH 12" OVERHANG

STANDARD FEATURES

FLOOR MODELS see page 7
Available in Deluxe or Supreme

SIDEWALL HEIGHT
6'6" sidewalls (7'1" inside headroom)
7' and 8' sidewalls optional

ROOF
4 pitch roof
Aluminum dripedge

CONSTRUCTION
Strongback Nailer
Primed Smartside Siding
2x4" wall framing
2x4" single top-plate
4" fascia trim
Air vents

DOORS
52" double doors with USA made lockset

WINDOWS
1 - 24x36" window with bar shutters

ELITE PACKAGE INCLUDES

7' sidewalls
6 pitch roof

LOFTS
4' loft building up to 10' long
2-4' loft in buildings over 10' long

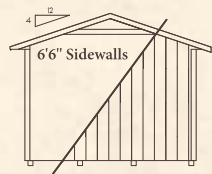

Standard
6'6" Sidewalls - 4 Pitch - No Loft

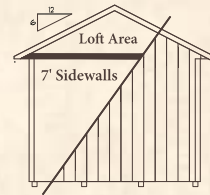

Elite Package
7' Sidewalls - 6 Pitch - Loft

BUILDING SIZES

WIDTH	DEPTH									STD. HEIGHT	ELITE HEIGHT
	8'	10'	12'	14'	16'	20'	24'	28'	32'		
8'	•	•	•							8' 8"	10'2"
10'		•	•	•	•	•				9'	10'8"
12'			•	•	•	•	•			9' 4"	11'2"
14'				•	•	•	•	•		9' 8"	11'8"
16'					•	•	•	•		10"	12'2"

ALSO AVAILABLE WITH 18" OVERHANG
(18" o.h. in front and 6" o.h. in back)

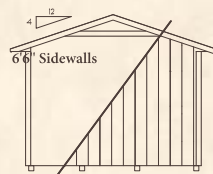

12" Overhang

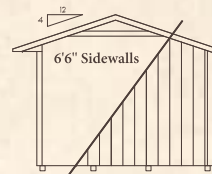

18" Overhang



10x20' Elite Gable with options



16x24' Elite Gable with options



10x16' Elite Gable with transom windows and metal roof



8x12' Gable

Alpine

gabriele

with 12"
overhang

Here's what
I'm thinking...

"The delivery
driver was very
knowledgeable and
did a wonderful job."

Kevin from
Canton, OH
May 2022

10x14' Alpine Gabriele
options shown:
elite package
dimensional shingles
30x36" window w/shutters & flowerbox
24x36" window w/shutters & flowerbox
painted dark grey w/white trim. black shutters

Alpine Cabana

STANDARD FEATURES

FLOOR MODELS see page 7
Available in Deluxe or Supreme

SIDEWALL HEIGHT
6'6" sidewalls on 10' and 12' wide buildings
7' sidewalls on 8' wide buildings

ROOF
3 pitch roof
2x6" rafters
Enclosed soffits
Frieze board
Metal roof
16" front overhang with rough sawn rafters

CONSTRUCTION
Strongback Nailer
Primed Smartside Siding
2x4" wall framing
2x4" single top-plate
6" Fascia trim
Air vents

DOORS
52" double doors with USA made lockset
30" single door with USA made lockset

WINDOWS
2- 24"x47" windows with trim

POPULAR OPTIONS

Transom windows
Decorative hinges

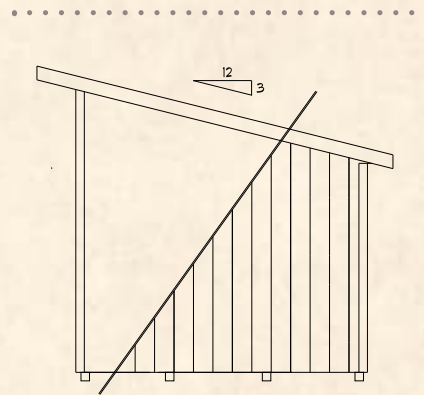

BUILDING SIZES

	WIDTH		DEPTH			STD. HEIGHT
	12'	14'	16'	20'	24'	
8'	•					10' 4"
10'	•	•	•	•		10' 1"
12'			•	•	•	10' 7"



10x14' with transom windows



10x14' Cabana Interior



8x12' Cabana with transom windows and pre-hung door

Alpine

Cabana



Here's what I'm thinking...

"This was our third barn in 4 years. We're very happy!"

Marik from Baltimore, OH
June 2022

10x14 Alpine Cabana
options shown:
transom windows
ramp
painted white w/light grey trim, dark grey doors

Alpine Barnstyle

WITH 4' HIGH SIDEWALLS

STANDARD FEATURES

FLOOR MODELS see page 7
Available in Deluxe or Supreme

SIDEWALL HEIGHT
4' sidewalls

ROOF
Aluminum dripedge

CONSTRUCTION
Primed Smartside Siding
2x4" wall framing
2x8" double top-plate
Air vents

LOFTS
see chart below

DOORS
52" double doors with USA made lockset

POPULAR OPTIONS

Cupola
30 year dimensional shingles
Double door threshold

BUILDING SIZES

WIDTH	DEPTH							STD. HEIGHT	LOFT(S)
	8'	10'	12'	14'	16'	20'	24'		
8'	•	•	•					8' 6"	2'
10'		•	•	•	•	•		9' 5"	4'
12'			•	•	•	•	•	9' 8"	two 4'
14'					•	•	•	10'	two 4'

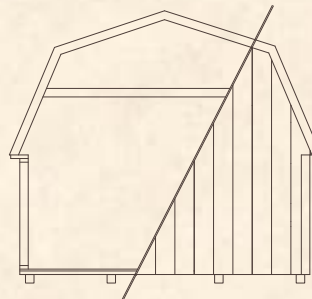

8x12' with vinyl siding



14x20' with transom windows, dim. shingles, and cupola



8x12' with treated ramp



10x16' with 72" doors and ramp

Alpine

Barnstyle

4' Sidewalls



Here's what I'm thinking...

"The delivery man was friendly, professional, and placed my structure right where I wanted it."

Peter from Lower Burrell, PA
June 2022

10x14' Alpine Barnstyle 4'
options shown:
60" doors, ramp
painted red w/white trim

Alpine Barnstyle

WITH 6'6" HIGH SIDEWALLS

STANDARD FEATURES

FLOOR MODELS see page 7
Available in Deluxe or Supreme

SIDEWALL HEIGHT
6'6" sidewalls
7' and 8' sidewalls optional

ROOF
Aluminum dripedge

CONSTRUCTION
Strongback Nailer
Primed Smartside Siding
2x4" wall framing
2x8" double top-plate
Air vents

LOFTS
see chart below

DOORS
52" double doors with USA made lockset

POPULAR OPTIONS

Windows
30 year dimensional shingles
Cupola
Weathervane

BUILDING SIZES

WIDTH	DEPTH										STD. HEIGHT	LOFT(S)
	8'	10'	12'	14'	16'	20'	24'	28'	32'			
8'	•	•	•								11'	2'
10'		•	•	•	•	•					11' 10"	4'
12'			•	•	•	•	•				12' 2"	two 4'
14'					•	•	•	•	•		12' 5"	two 4'
16'						•	•	•	•		12' 8"	two 4'

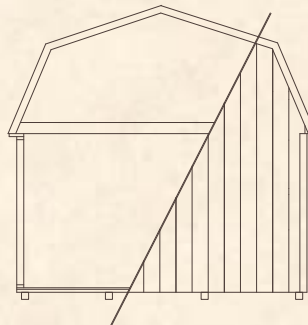

16x24' with garage door, 8' sidewalls, window, and dim. shingles



16x24' with 24x27" windows and shutters, loft door, 10' ridgetite and ridgevent, and custom ramp



14x28' with windows and shutters, transom windows, and custom ramps

Alpine

barnstyle

6'6" Sidewalls

Here's what I'm thinking...

"What I liked best was the customer first attitude of all the employees."

Harold from Parkersburg, WV
June 2022

12x16' Alpine Barnstyle 6'6"
options shown:
treated ramp
painted avocado green w/buckskin trim

Restructure your backyard

Alpine Barnstyle

WITH 6'6" HIGH SIDEWALLS & 4' OVERHANG

STANDARD FEATURES

FLOOR MODELS see page 7
Available in Deluxe or Supreme

SIDEWALL HEIGHT
6'6" sidewalls
7' and 8' sidewalls optional

ROOF
Aluminum dripedge
4' self-supporting overhang
6' overhang optional
2x6" rafters

CONSTRUCTION
Strongback Nailer
Primed Smartside Siding
2x4" wall framing
2x8" double top-plate
6" fascia trim
Air vents

LOFTS
see chart below

DOORS
52" double doors with USA made lockset

BUILDING SIZES

WIDTH	DEPTH							STD. HEIGHT	LOFT(S)
	12'	14'	16'	20'	24'	28'	32'		
10'	•	•	•	•				11' 10"	4'
12'	•	•	•	•	•			12' 2"	two 4'
14'			•	•	•	•	•	12' 5"	two 4'
16'				•	•	•	•	12' 8"	two 4'

POPULAR OPTIONS

Treated deck
Posts with "Y" braces
Entrance door
7' sidewalls
Windows



16x24' with 6' overhang and two windows



16x24' with garage door and two windows



10x20' with options

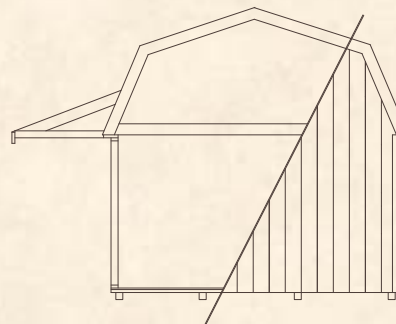

self-supporting overhang

Alpine

barnstyle

4' overhang

Here's what
I'm thinking...

"I couldn't be
happier. Excellent
workmanship
and quality."

Cindy from
Berea, OH
July 2022

12x20' Barnstyle
options shown:
60" doors with transom window
36" single door with transom window
2 windows
7" walls
metal roof
treated deck
6" posts
stained driftwood w/black trim

Alpine A-Frame

WITH 4' OVERHANG

STANDARD FEATURES

FLOOR MODELS see page 7
Available in Deluxe or Supreme

SIDEWALL HEIGHT
6'6" sidewalls
7' and 8' sidewalls optional

ROOF
12 pitch roof
Aluminum dripedge
4' overhang

CONSTRUCTION
Strongback Nailer
Primed Smartside Siding
2x4" wall framing
2x4" single top-plate
6" fascia trim
Air vents
4' treated deck with posts and "Y" braces

LOFTS
2-4' lofts in buildings over 10' long

DOORS
52" double doors with USA made lockset
30" single door with USA made lockset

WINDOWS
1-24x36" window with bar shutters

POPULAR OPTIONS

7' sidewalls
Insulated windows
30 year dimensional shingles

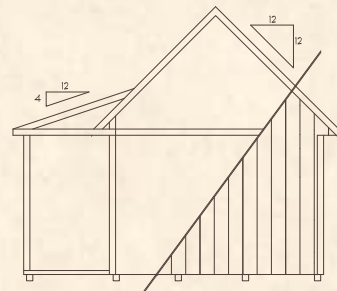

BUILDING SIZES

	WIDTH		DEPTH				HEIGHT	LOFTS
	14'	16'	20'	24'	28'	32'		
10'	•	•	•				13'	two-4'
12'		•	•	•			14'	two-4'
14'			•	•			15'	two-4'
16'			•	•	•	•	16'	two-4'



12x16' with 6' porch and numerous options



14x20' with 7' sidewalls, transom windows, and dim. shingles



12x14' with 7' walls, dim. shingles, and numerous options



Interior as an office

Alpine

sh-frame

Here's what I'm thinking...

"The shed is well made. Delivery and installation were professionally done."

Rose from
Niles, OH
October 2022

10x14' A-Frame
options shown:
7' sidewalls
dimensional shingles
24x36" window w/shutters
painted avocado green w/buckskin trim

Alpine Cottage

STANDARD FEATURES

FLOOR MODELS see page 7
Available in Deluxe or Supreme

SIDEWALL HEIGHT
6'6" sidewalls (7' 1" inside headroom)
7' and 8' sidewalls optional

ROOF
6 pitch roof
Aluminum dripedge

CONSTRUCTION
Strongback Nailer
Primed Smartside Siding
2x4" wall framing
2x4" single top-plate
4" fascia trim
Air vents
4' treated deck with posts and "Y" braces

DOORS
52" double doors with USA made lockset
30" single door with USA made lockset

WINDOWS
1 - 24x36" window with bar shutters

ELITE PACKAGE INCLUDES

7' sidewalls
6 pitch roof

LOFTS
4' loft in building up to 10' long
2-4' lofts in buildings over 10' long



Standard
6'6" Sidewalls - 4 Pitch - No Loft



Elite Package
7' Sidewalls - 6 Pitch - Loft

BUILDING SIZES

	DEPTH								STD. HEIGHT	ELITE HEIGHT
	10'	12'	14'	16'	20'	24'	28'	32'		
8'		•							10' 5"	11' 1"
10'	•	•	•	•	•				10' 11"	11' 7"
12'		•	•	•	•	•			11' 5"	12' 1"
14'				•	•	•	•	•	12' 1"	12' 9"
16'					•	•	•	•	12' 5"	13' 3"

Note: Gable style buildings with 12", 18" and 42" overhangs do not include a porch floor.

Cottage style buildings include a porch floor.



12x16' Elite Cottage with 8/12 pitch roof and many options



16x24' with vinyl siding, 8' sidewalls, dim. shingles, steel door, and windows



16x24' Elite Cottage, roof awning, cupola, and many options



10x20' Elite Cottage, 6' porch, and many options

Alpine

Cottage



**10x16' Cottage
options shown:
elite package
double 30x36" window with shutters
transom windows
metal roof
6" posts
painted dark grey w/white trim, black shutters**

Here's what I'm thinking...

"Kenny was phenomenal. He was patient and went above and beyond to help us."

*Cassidy from Canal Winchester
July 2022*

Alpine Skyview

STANDARD FEATURES

FLOOR MODELS see page 7
Available in Deluxe or Supreme

SIDEWALL HEIGHT

6'6" sidewalls
7' and 8' sidewalls optional

ROOF

8 pitch roof (9 pitch roof on 8x12' Skyview)
8' dormer with transom windows
Enclosed soffits
Frieze board
Aluminum dripedge
30 year dimensional shingles

CONSTRUCTION

Strongback Nailer
Primed Smartside Siding
2x4" wall framing
2x4" single top plate
4" fascia trim
Air vents

LOFTS

2-4' lofts in buildings over 10' long

DOORS

52" double doors with USA made lockset
30" single door with USA made lockset

WINDOWS

2 - 24x36" windows with 1 set bar shutters

POPULAR OPTIONS

Transom windows
Metal roof
Flowerboxes



BUILDING SIZES

	WIDTH		DEPTH					STD. HEIGHT
	12'	14'	16'	20'	24'	28'	32'	
8'	•							10' 8"
10'		•	•	•				10' 11"
12'			•	•	•			11' 7"
14'				•	•	•	•	12' 3"
16'					•	•	•	12' 11"



16x32' with 8' walls and numerous options



10x16' with lap siding and transom windows



10x12' with transom windows and ramp

Alpine

Skyview™



Here's what
I'm thinking...

"We love our barn.
The workmanship
is amazing."

Richard from
Warren, OH
August 2022

**10x16~ Skyview
options shown:
transom windows
1- extra 24x36~ window
stained driftwood w/ black trim**

Alpine Cove

STANDARD FEATURES

FLOOR MODELS see page 7
Available in Deluxe or Supreme

SIDEWALL HEIGHT
6'6" sidewalls
7' and 8' sidewalls optional

ROOF
6 pitch roof
Aluminum dripedge
Enclosed soffits
Frieze board
30 year dimensional shingles

CONSTRUCTION
Strongback Nailer
Primed Smartside Siding
2x4" wall framing
2x4" double top-plate
4" fascia trim
Air vents

LOFTS
4' loft in buildings up to 10' long
2-4' lofts in buildings over 10' over

DOORS
52" double doors with USA made lockset
30" single door with USA made lockset

WINDOWS
2-24x36" windows with bar shutters

POPULAR OPTIONS

Transom windows
Decorative hinges

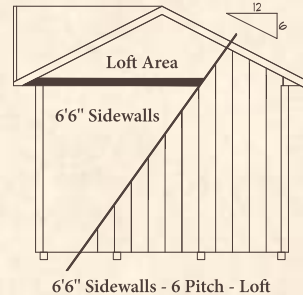

BUILDING SIZES

	WIDTH		DEPTH					STD. HEIGHT
	12'	14'	16'	20'	24'	28'	32'	
8'	•							9' 9"
10'		•	•	•				10' 3"
12'			•	•	•			10' 9"
14'				•	•	•	•	11' 3"
16'					•	•	•	10' 9"



10x14' Alpine Cove with 60" doors and ramp



16x32' with metal roof and options



10x14' with transom windows and ramp



The Cove interior

Alpine

COVE



Here's what I'm thinking...

"I had a great overall experience from beginning to the end."

Lois from Monaca, PA
September 2022

10x16' Cove
options shown:
60" double doors
transom windows
flowerboxes
painted dark grey w/white trim

Alpine Frontier

STANDARD FEATURES

FLOOR MODELS see page 7
Available in Deluxe or Supreme

SIDEWALL HEIGHT
6'6" sidewalls
7' and 8' sidewalls optional

ROOF
12 pitch roof
Roof apron on front gable
Enclosed soffits
Frieze board
Aluminum dripedge

CONSTRUCTION
Strongback Nailer
Primed Smartside Siding
2x4" wall framing
2x4" single top-plate
6" fascia trim
Air vents

LOFTS
4' loft in buildings up to 10' long
2-4' lofts in buildings over 10' long

DOORS
52" double doors with USA made lockset
30" single door with USA made lockset

WINDOWS
1-24x36" window with bar shutters
1-18x27" window with bar shutters in front gable

POPULAR OPTIONS

Loft railing
Captain's ladder to loft
Garage Door
7' sidewalls
Shake siding

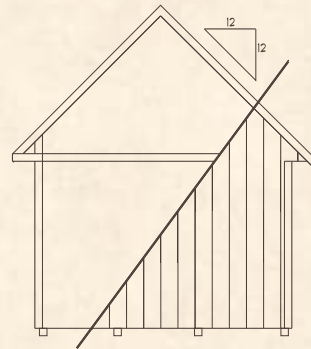

BUILDING SIZES

	WIDTH						STD. HEIGHT
	14'	16'	20'	24'	28'	32'	
10'	•	•	•				13'
12'		•	•	•			14'
14'			•	•	•		15'
16'				•	•	•	16'



12x20' with options



10x14' with extra windows, transom windows, and ramps



12x16' with an extra window and ramp

Alpine
Frontier

Here's what
I'm thinking...

"I will be sure to tell
everyone about our
great experience."

Victor from
Grafton, OH
August 2022

12x16' Frontier
options shown:
carriage house garage door
7" sidewalls
vinyl siding
shake siding on gable
dimensional shingles
vinyl siding: alpine clay w/white trim

Alpine Gable

WITH 42" OVERHANG

STANDARD FEATURES

FLOOR MODELS see page 7
Available in Deluxe or Supreme

SIDEWALL HEIGHT
6'6" sidewalls (7' 1" inside headroom)
7' and 8' sidewalls optional

ROOF
4 pitch roof
Aluminum dripedge
42" overhang

CONSTRUCTION
Strongback Nailer
Primed Smartside Siding
2x4" wall framing
2x4" single top-plate
Air vents

DOORS
52" double doors with USA made lockset

WINDOWS
1- 24x36" window with bar shutters



ELITE PACKAGE INCLUDES

7' sidewalls
6 pitch roof

LOFTS
4' loft in buildings up to 10' long
2-4' lofts in buildings over 10' long

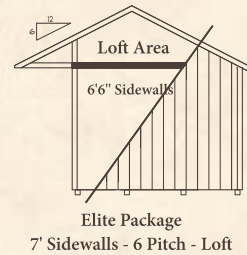
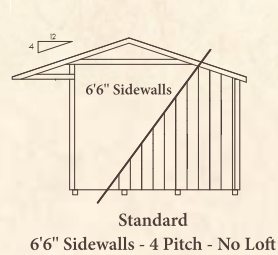

BUILDING SIZES

WIDTH	DEPTH							STD. HEIGHT	ELITE HEIGHT
	8'	10'	12'	14'	16'	20'	24'		
8'	•	•	•					9'	10' 8"
10'		•	•	•	•	•		9' 4"	11' 2"
12'			•	•	•	•	•	9' 8"	11' 8"



Alpine Quaker

STANDARD FEATURES

FLOOR MODELS see page 7
Available in Deluxe or Supreme

SIDEWALL HEIGHT
6'6" sidewalls (7' 1" inside headroom)
7' and 8' sidewalls optional

ROOF
Aluminum dripedge

CONSTRUCTION
Strongback Nailer
Primed Smartside Siding
2x4" wall framing
2x4" single top-plate
4" fascia trim
Air vents

DOORS
52" double doors with USA made lockset

WINDOWS
1- 24x36" window with bar shutters

ELITE PACKAGE INCLUDES

7' sidewalls

LOFTS
4' loft in buildings up to 10' long
2-4' lofts in buildings over 10' long

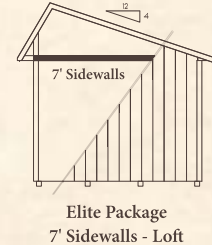
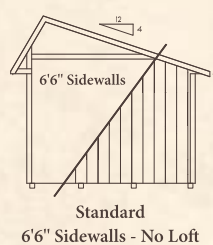

BUILDING SIZES

WIDTH	DEPTH							STD. HEIGHT	ELITE HEIGHT
	8'	10'	12'	14'	16'	20'	24'		
8'	•	•	•					9'8"	10'4"
10'		•	•	•	•	•		10'2"	10'10"
12'			•	•	•	•	•	10'5"	11'1"

Ez-Fit Sheds

Small sheds with big features

STANDARD FEATURES

FLOOR MODELS see page 7
Available in Deluxe or Supreme

SIDEWALL HEIGHT
6'6" sidewalls
7' and 8' sidewalls optional

ROOF
6 pitch roof
25 year shingles
Aluminum dripedge

CONSTRUCTION
Strongback Nailer
Primed Smartside Siding
2x4" double top-plate
6" fascia trim
Air vents

LOFTS
4' loft in buildings up to 10' long
2-4' lofts in buildings over 10' long

DOORS
60" double doors with USA made lockset
12" Decorative hinges

WINDOWS
"Z" Shutters

THREE BUILDING STYLES

RIVERSIDE
60" double doors
30" single door
2-24x36" windows



HERITAGE
60" double doors
1-24x36" window
1-30x36" window



HOMESTEAD
60" double doors
1- Double 30x36" window



10x14' Riverside with transom windows, metal roof, awning, and flowerboxes



10x12' Heritage transom windows, flowerboxes, and dim. shingles



10x12' Riverside transom windows, flowerboxes, and cupola



10x14' Heritage with 7' walls, transom windows, and metal roof

EZ-FIT SHED SIZES

WIDTH	DEPTH							HEIGHT
	8'	10'	12'	14'	16'	20'	24'	
8'	•	•	•					9' 9"
10'		•	•	•	•	•		10' 3"
12'					•	•	•	10' 9"

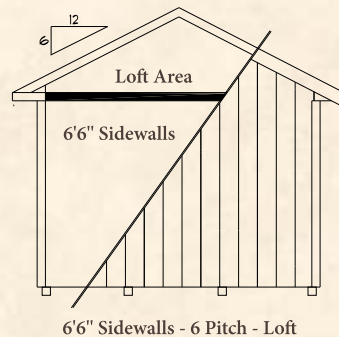

EZ-Fit
Riverside



10x14' Riverside
options shown:
dimensional shingles
transom windows
vinyl flowerboxes
16" cupola
weathervane
treated ramp
painted avocado green w/beige trim

Here's what I'm thinking...

"The installers were on time, professional, very nice guys."

Tom from Brecksville, OH
September 2022

EZ-Fit

homestead

Here's what
I'm thinking...

"Thanks!
You have the
best buildings!"

Mike from
Hayesville, OH
August 2022

See page 32 for features,
options, and building sizes!

10x12' Homestead
options shown:
dimensional shingles
transom windows
vinyl flowerboxes
16" cupola
horse weathervane
painted red w/white trim

See page 32 for features,
options, and building sizes!

EZ-Fit
Heritage

Here's what
I'm thinking...

"The shed is
beautiful and
high quality."

Randall from
Cuyahoga Falls, OH
October 2022

10x12' Heritage
options shown:
dimensional shingles
transom windows
vinyl flowerboxes
decorative flowerbox holders
16" cupola
eagle weathervane
painted beige w/clay

Ez-Fit Greenhouse

STANDARD FEATURES

FLOOR MODELS see page 7
Available in Deluxe or Supreme

SIDEWALL HEIGHT
6'6" sidewalls
7' and 8' sidewalls available

ROOF
6 pitch roof
Sun Sky roofing

CONSTRUCTION
Strongback nailer
Primed Smartside Siding
2x4" double top plate
air vents

SHELVING
24" wide molded greenhouse shelving

DOORS
30" single door with
double transom windows

WINDOWS
24x47" windows, amount varies by size of
greenhouse. See chart in next column.

GREENHOUSE SIZES

	WIDTH		DEPTH			HEIGHT
	8'	10'	12'	14'	16'	
8' Wide	•	•	•			9' 9"
WINDOWS PER BUILDING	9	11	13			
10' Wide			•	•	•	10' 3"
WINDOWS PER BUILDING			14	14	16	
WINDOWS PER LENGTH OF WALL	3	4	5	5	6	

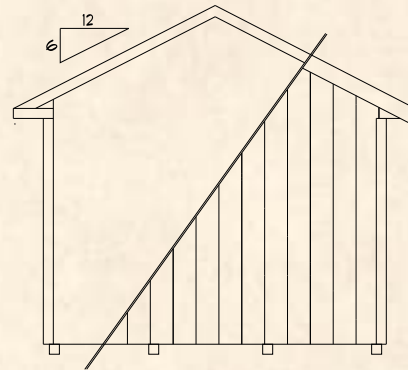

8x12' Greenhouse with optional 7' walls



8x12' Greenhouse



8x12' Greenhouse Interior

EZ-Fit

greenhouse



Here's what I'm thinking...

"Your delivery man was beyond awesome. Please thank him for us and give him a raise."

William from Massillon, OH
January 2022

8x12' Greenhouse
options shown:
7' walls
painted dark grey w/white trim

2000 Series

WITH 4' HIGH SIDEWALLS

Our 2000 Series sheds offer plenty of storage at an affordable price. Includes 3/4" C.D.X. flooring with optional heavier floors available.

STANDARD FEATURES

FLOOR MODELS see page 7

3/4" C.D.X. plywood floor
Available in Standard, Deluxe or Supreme

SIDEWALL HEIGHT

4' sidewalls

ROOF

Aluminum dripedge
6" roof overhang front and back

CONSTRUCTION

Primed Smartside Siding
2x4" wall framing
2x4" single top-plate
Wall framing 24" o.c.
Air vents

DOORS

52" double doors with USA made lockset

COMPARE TO

Alpine Barnstyle

WITH 4' HIGH SIDEWALLS

2000 Series Does Not Include:

2x8" double top plate
Lofts
12" roof overhang front and back
3/4" ProStruct or 2x6" T.G. flooring

2000 Series Includes:

2x4" single top plate
6" roof overhang front and back
3/4" C.D.X. plywood floor
Less headroom than Alpine Barnstyle 4'
12' wide 2000 Series floor width: 11' 6"

BUILDING SIZES

WIDTH	DEPTH							HEIGHT
	8'	10'	12'	14'	16'	20'	24'	
8'	•	•	•					7' 10"
10'		•	•	•	•	•		8' 3"
12' *					•	•	•	8' 7"

*12' wide 2000 Series floor width: 11' 6"

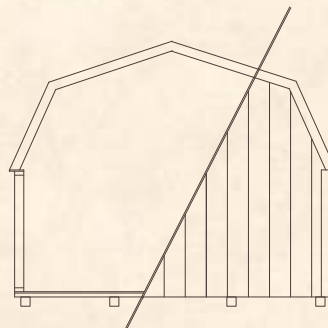

8x12' 2000 Series



8x12' 2000 Series



10x12' 2000 Series 60" doors and ramp

2000

Series

4' Sidewalls

Here's what
I'm thinking...

"Communication
was great they
helped us pick the
right building for
our needs."

Amy from
Coshocton, OH
August 2022

10x16' 2000 Series 4'
options shown:
standard features
painted buckskin w/white trim

Restructure your backyard

2000 Series

WITH 6'6" HIGH SIDEWALLS

Our 2000 Series sheds offer plenty of storage at an affordable price. Includes 3/4" C.D.X. flooring with optional heavier floors available.

STANDARD FEATURES

FLOOR MODELS see page 7

3/4" C.D.X. plywood floor
Available in Standard, Deluxe, or Supreme

SIDEWALL HEIGHT

6'6" sidewalls

ROOF

Aluminum dripedge
6" roof overhang front and back

CONSTRUCTION

Strongback Nailer
Primed Smartside Siding
2x4" wall framing
2x4" single top-plate
Wall framing 24" o.c.
Air vents

DOORS

52" double doors with USA made lockset

BUILDING SIZES

WIDTH	DEPTH							HEIGHT
	8'	10'	12'	14'	16'	20'	24'	
8'	•	•	•					10' 5"
10'		•	•	•	•	•		10' 8"
12' *					•	•	•	10' 11"

*12' wide 2000 Series floor width: 11' 6"

COMPARE TO

Alpine Barnstyle WITH 6'6" HIGH SIDEWALLS

2000 Series Does Not Include:

2x8" double top plate
Lofts
12" roof overhang front and back
3/4" ProStruct or 2x6" T.G. flooring

2000 Series Includes:

2x4" single top plate
6" roof overhang front and back
3/4" C.D.X. plywood floor
Less headroom than Alpine Barnstyle 6'6"
12' wide 2000 Series floor width: 11' 6"

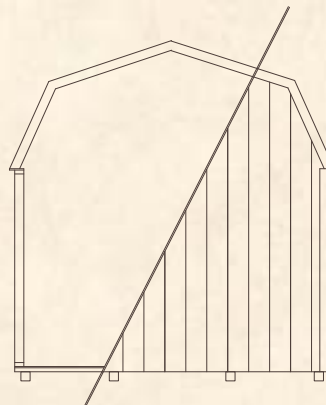

12x16' with window and ramp



10x20' with numerous options



10x12' with ramp and ridge light

2000

Series

6'6" Sidewalls



Here's what
I'm thinking...

"Every person that
we worked with was
friendly, professional,
and knowledgeable."

Jeff from
Canal Winchester, OH
August 2022

10x16' 2000 Series 6'6"

options shown:

72" doors

ridge light

ramp

painted clay w/white trim

2000 Series Gable

Our 2000 Series sheds offer plenty of storage at an affordable price. Includes 3/4" C.D.X. flooring with optional heavier floors available.

STANDARD FEATURES

FLOOR MODELS see page 7

3/4" C.D.X. plywood floor
Available in Standard, Deluxe, or Supreme

SIDEWALL HEIGHT

6'6" sidewalls

ROOF

Aluminum dripedge
6" roof overhang front and back
6 pitch roof

CONSTRUCTION

Strongback Nailer
Primed Smartside Siding
2x4" wall framing
2x4" single top-plate
4" fascia trim
Wall framing 24" o.c.
Air vents

DOORS

52" double doors with USA made lockset

COMPARE TO

Alpine Gable WITH 12" OVERHANG

2000 Series Gable Does Not Include:
12" roof overhang on all sides
lofts
3/4" ProStruct or 2x6" T.G. flooring

2000 Series Includes:
2x4" single top plate
6" roof overhang front and back
3/4" C.D.X. plywood floor
12' wide 2000 Series floor width: 11' 6"

BUILDING SIZES

WIDTH	DEPTH							HEIGHT
	8'	10'	12'	14'	16'	20'	24'	
8'		•	•					9' 1"
10'		•	•	•	•	•		9' 7"
12' *					•	•	•	10'

*12' wide 2000 Series floor width: 11' 6"

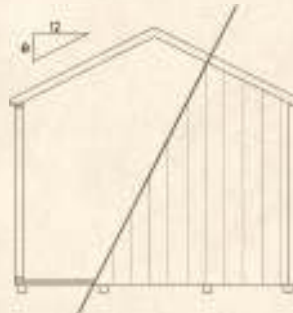

8x10' 2000 Series Gable



10x14' 2000 Series Gable with air vents and ramp



12x20' 2000 Series Gable with options

2000

Series

Gable



Here's what I'm thinking...

"I liked the barn I got last year so much I got another one."

Roberta from Wooster, OH
October 2022

10x12' 2000 Series Gable
options shown:
60" doors, ramp,
transom windows
painted buckskin w/white trim

2000 Series Garage

Our 2000 Series sheds offer plenty of storage at an affordable price.

STANDARD FEATURES

FLOOR MODELS see page 7
 Available in Deluxe or Supreme
 2x4" treated floor joists 12" o.c.
 3/4" ProStruct floor

SIDEWALL HEIGHT
 6'6" sidewalls – on barnstyle
 7' sidewalls – on gable style

ROOF
 6 pitch roof – on gable style
 6" roof overhang front and back
 Aluminum dripedge

CONSTRUCTION
 Strongback Nailer
 Primed Smartside Siding
 2x4" wall framing
 2x4" single top-plate
 Air vents

LOFTS
 4' loft in back of building

DOORS
 36" single door with USA made lockset
 8'x6'6" non-insulated garage door
 Metal garage door threshold

WINDOWS
 1-24x36" aluminum window

TWO BUILDING STYLES

GABLE STYLE
 7' walls
 6 pitch roof
 10'9" height



BARNSTYLE
 6'6" walls
 10'11" height

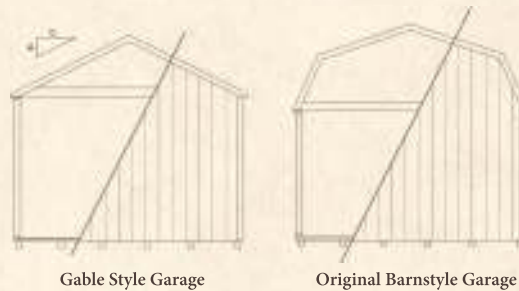

BUILDING SIZES

WIDTH	DEPTH				HEIGHT BARN:	HEIGHT GABLE:
	16'	20'	24'	28'		
12'*	•	•	•	•	10' 11"	10' 9"

*2000 Series Garage floor width: 11' 6"

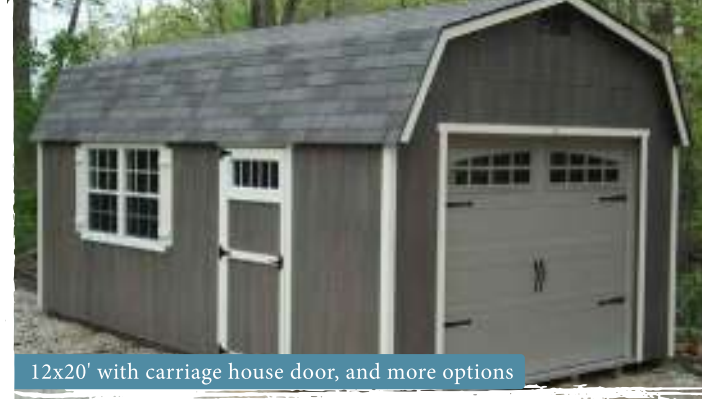

2000

Series

Garage

Here's what I'm thinking...

"The two guys who built my shed were outstanding."

Joseph from Lake Milton, OH
October 2022

12x20' 2000 Series Garage
options shown:
standard features
painted buckskin w/white trim

Alpine Barnstyle Cabin

WITH 6' OVERHANG

LARGE STRUCTURES

STANDARD FEATURES

FLOOR MODELS see page 7
see price list for flooring options

SIDEWALL HEIGHT

8' sidewalls (7'1" first floor headroom)
6' rafter (6'5" second floor headroom)

ROOF

6' overhang
2x6" rafters
Aluminum dripegde
30 year dimensional shingles

CONSTRUCTION

Strongback Nailer
Primed Smartside Siding
Treated deck
Posts with "Y" braces
2x4" wall framing
Air vents
Synthetic felt paper
Truss anchor screws

LOFTS

Full loft with steps
2x10" loft joists 16" o.c. below top plate

DOORS

Entrance door with glass

POPULAR OPTIONS

Vinyl insulated windows
Ridgevent and vented soffit

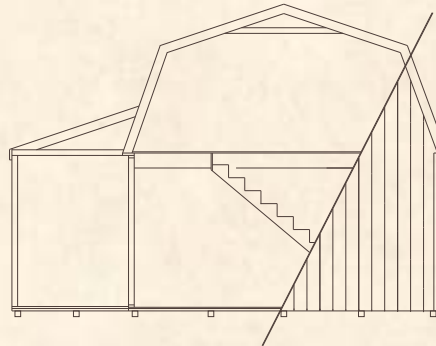

BUILDING SIZES

WIDTH	DEPTH				HEIGHT
	20'	24'	28'	32'	
16'	•	•	•	•	16' 4"



16x24' with vinyl siding



standard feature – full loft with steps and railings



16x24' with metal roof and other options



16x24' with two 6' overhangs, post foundation, and other options

Alpine

Barnstyle

Cabin

Here's what
I'm thinking...

"The men who
delivered my building
were wonderful.
They did a great
job and cleaned up."

Lisa from
Moundsville, WV
October 2022

16x24' Barnstyle Cabin
options shown:
30x36" windows
22" cupola
weathervane
painted clay w/avocado green trim

Alpine A-Frame Cabin

WITH 6' OVERHANG

STANDARD FEATURES

FLOOR MODELS see page 7
see price list for flooring options

SIDEWALL HEIGHT
8' sidewalls

ROOF
12 pitch roof
Aluminum dripedge
6' overhang
30 year dimensional shingles

CONSTRUCTION

Strongback Nailer
Primed Smartside Siding
2x4" wall framing
2x4" double top-plate
Air vents

Wall studs 16" o.c.
6" fascia trim
Synthetic felt paper
Truss anchor screws

DOORS

Entrance door with glass

LOFTS

Full loft w/steps, landing, and railing
Loft below top plate
2x10" loft joists 16" o.c. 16' wide buildings
14" floor trusses 24" o.c. 20' wide buildings
16" floor trusses 24" o.c. 24' wide buildings

DECKS

6' deck and "Y" posts are standard
on 16' wide cabins

6' deck and posts are optional on 20'
and 24' wide cabins

POPULAR OPTIONS

Vinyl insulated windows
Ridgevent and vented soffit
Additional doors

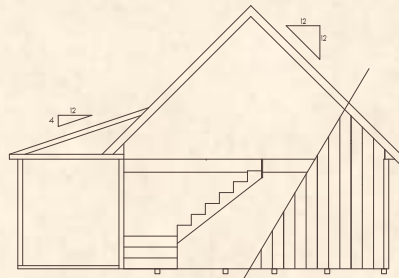

BUILDING SIZES

	DEPTH						HEIGHT
	20'	24'	28'	32'	36'	40'	
16'	•	•	•	•			17' 7"
20'		•	•	•	•	•	19' 9"
24'		•	•	•	•	•	21' 9"



20x28' with options



Full loft, standard feature. Interior finish/work by customer



16x20' with vinyl siding



24x36' with attached garage

Alpine

a-frame

Cabin

Here's what
I'm thinking...

"Our salesman
Andy was very
informative and
patient."

Gretchen from
Massillon, OH
September 2022

16x24' A-Frame Cabin
options shown:
30x36" window with shutters
treated porch railing
painted avocado green w/buckskin trim

Alpine Garages

STANDARD FEATURES

FLOOR MODEL

Permanent foundation required
- see page 54.

SIDEWALL HEIGHT

8' sidewalls

ROOF

4 pitch roof
Aluminum dripedge
OSB roof sheathing
30 year dimensional shingles
12" overhang on all sides

CONSTRUCTION

Strongback Nailer
Primed Smartside Siding
2x4" wall framing
2x4" double top-plate
Wall studs 16" o.c.
Air vents
Synthetic felt paper
Truss Anchor Screws

DOORS

Entrance door with glass

POPULAR OPTIONS

Vinyl insulated windows
Ridgevent and vented soffit
8-16' wide garage doors
Vinyl siding
Steeper roof pitch
2x6" walls

GARAGE DOOR COLORS

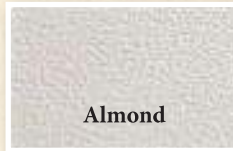

Almond



White



Sandstone

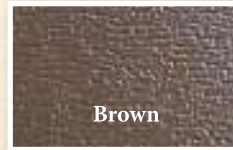

Brown

Due to variables in the printing process, color samples may vary in color and sheen from the actual materials.

BUILDING SIZES

WIDTH	DEPTH						HEIGHT
	20'	24'	28'	32'	36'	40'	
20'	•	•	•	•	•	•	12'
24'	•	•	•	•	•	•	12' 10"

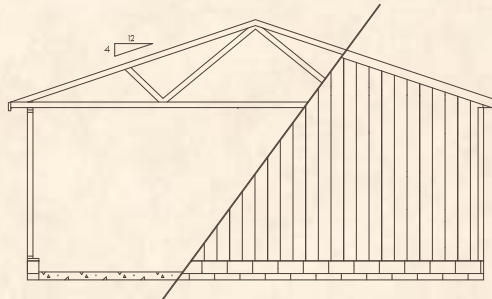

24x32' garage



26x40' garage



28x40' Garage with options



20x30' garage

Alpine

garages

Here's what
I'm thinking...

"The installers
arrived early
and did an
excellent job."

Vicki from
Cuyahoga Falls, OH
October 2022

**24x28' Garage
options shown:
2-9x7' garage doors
45° garage door corners
6 pitch roof
cupola & weathervane
gutters**

Alpine Loft Barns

STANDARD FEATURES

FLOOR MODELS

Permanent foundation required
- see page 54.

SIDEWALL HEIGHT

8' sidewalls

ROOF

Aluminum dripedge
2x6" roof trusses 24" o.c.
OSB roof sheathing
30 year dimensional shingles

CONSTRUCTION

Strongback Nailer
Primed Smartside Siding
2x4" wall framing
Wall studs 16" o.c.

Air vents
Synthetic felt paper
Steps and railings
Truss anchor screws

LOFTS

Full loft (see chart for headroom)
Clearspan floor trusses for loft area

DOORS

Entrance door with glass

POPULAR OPTIONS

Vinyl insulated windows
Ridgevent and vented soffit
8' Overhang with posts
Porch and railing
8'-16' Wide Garage Doors
2x6" Walls

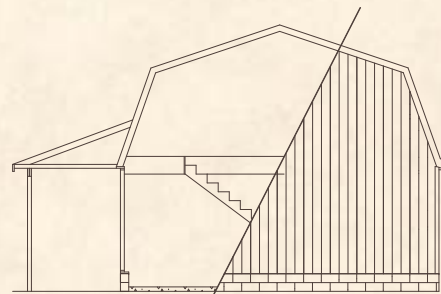
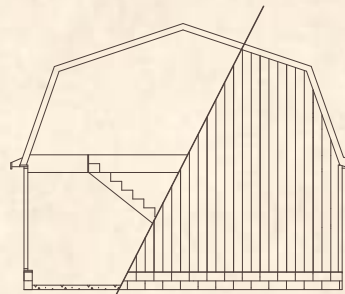

BUILDING SIZES

WIDTH	DEPTH						BLDG. HEIGHT	LOFT HEIGHT
	20'	24'	28'	32'	36'	40'		
20'	•	•	•	•	•	•	18'	7' 10"
24'	•	•	•	•	•	•	18' 8"	8' 5"



24x32' Loft Barn with metal roof and options



24x32' Loft Barn



24x40' with 8' overhang



24x48' with 8' overhang

Alpine

loft barns

**24x40' Loft Barn
options shown:
8' overhang
posts with "Y" braces
garage door, loft door
windows, cupola
painted red w/white trim**

**Here's what
I'm thinking...**

*"The salesman
was very nice
and had great
communication."*

*Pam from
Pataskala, OH
October 2022*



Site Prep

Alpine Structures offers several of these site-prep options.
Ask your salesman for availability in your area.

SMALL STRUCTURES



level limestone base

1. Limestone base should be 12" larger than building on four sides.
2. Remove 3-4" of sod.
3. Fill back in with No. 8 or No. 57 limestone.
4. Make sure entire area of limestone is level.



patio block base

8"x16" x 2" thick concrete patio blocks are placed underneath each skid a maximum of 6' on center.



block/4x4" foundation

4x4"s are placed crossways underneath building. 4x4" supported with solid concrete blocks on low side and dug into ground (as needed) on high side.

great for smaller sheds!

LARGE STRUCTURES



post and beam foundation

Pressure/treated posts with 2x8" stringers for sloped applications.



post and rim foundation

Pressure/treated posts 8' o.c. with 2x8" treated rim boards and 2x8" treated cap.



block foundation

Block foundation with frost protected footer and concrete floor.



An Attractive, Durable Finish For Sheds

A flooring designed and warranted specifically for sheds, LP® ProStruct® Flooring with SmartFinish® features a durable overlay for a beautiful, professional-grade appearance. With no knots or voids, it's a welcome change from building with traditional plywood flooring. Plus, unlike plywood shed floors, LP® ProStruct® Flooring with SmartFinish® is treated with the LP® SmartGuard® process for longer-lasting performance in a variety of climates/weather.



FLOORING



Features & Benefits

A Shed Floor With Protection Against Decay & Damage

The shed floor you've been searching for is here, specially treated with SmartGuard® wood strand technology to resist fungal decay and termite damage.

.....

An Easy Shed Floor Install

The LP® ProStruct® Flooring with SmartFinish® installs like conventional floor panels.

Knot and Void Free

Durable overlay for a professional-grade appearance with no knots or voids so your shed floor is as durable as it is attractive.

.....

Longer-Lasting Performance

SmartFinish® flooring has excellent resistance to warping, splitting and cupping.

Siding Options

LP SmartSide Siding

Standard on all buildings



A Natural Defense Against Nature

All LP® SmartSide® products are treated to the core through LP's proprietary SmartGuard® process. With four components of protection, the SmartGuard process adds strength and helps LP SmartSide products withstand impacts, freeze/thaw cycles, high humidity, fungal decay and more. SmartSide siding is backed by a 50 year prorated limited warranty.

We're proud to offer SmartSide® standard on all of our buildings.

Waxes

Special water-resistant waxes coat each strand or fiber of wood for enhanced durability in rainy, humid environments.



Resin-Saturated Overlay

Offering the final layer of protection against the elements, a resin-saturated overlay resists moisture intrusion while providing a durable base for quality paint adhesion and beauty.

Zinc Borate

Engineered wood products treated with zinc borate have been proven to effectively resist damage from termites and fungal decay for decades. Safe for children and pets, this naturally occurring additive provides long-lasting performance that preserves the beauty of LP SmartSide Trim and Siding.



Advanced Binders

LP SmartSide Trim and Siding provide incredible strength to resist impact damage thanks to their industrial grade binders and resins. You'll have the confidence of knowing that your siding can stand up to everyday airborne debris such as hail, sticks, or golf balls.

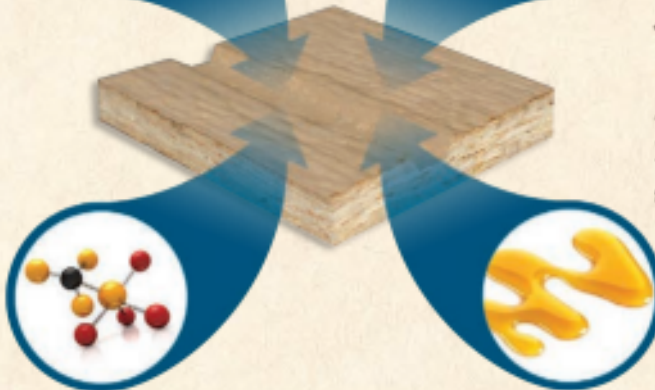

LP Horizontal Lap Siding

Standard features

- 50 year prorated, limited warranty
- Treated with a Zinc Borate application
- Resistant to fungal decay and termite damage
- Primed face



10x16' Elite Gable with options



10x14' Elite Gable

Vinyl Siding

Standard features

- Double 4" dutchlap siding
- OSB subsiding & sheathing
- 4' Ridgevent
- Available on all sizes & styles

Options

- Flowerboxes
- Vinyl railing

Base color includes

- Siding
- Corner Trim
- Soffit

Trim color includes

- Door Trim
- Fascia



14x20' Elite Gable



10x14' Elite Gable



Vinyl sided buildings come standard with 60" wide Fiberglass slab doors with transom windows. 6 panel and 9 lite doors also available.



alpine white



alpine clay



alpine grey



alpine sandalwood

Due to variables in the printing process, color samples may vary in color and sheen from the actual materials.

Roof Options

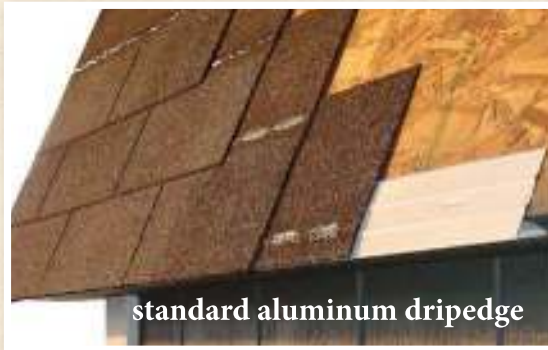

STANDARD 3-TAB SHINGLES



DIMENSIONAL SHINGLES

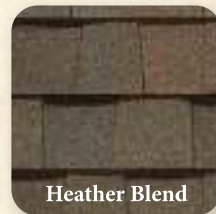
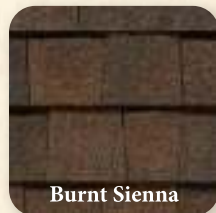

METAL ROOF

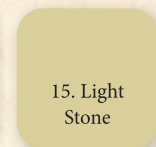
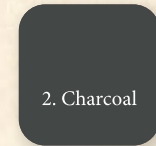

Window & Door Options

VINYL SHUTTER & FLOWERBOX COLORS

- 1. White
- 2. Black
- 3. Brown
- 4. Green
- 5. Grey
- 6. Clay



WINDOWS SIZES & STYLES

Aluminum

18x27" | 24x36" | 24x47" | 30x36"

Insulated

24x36" | 36x40"

- 1. Window with trim
- 2. Wooden bar shutters
- 3. Wooden "Z" shutters and vinyl flowerbox
- 4. Vinyl shutters
- 5. 24x47" window with transom
- 6. Black aluminum windows - New for 2023!

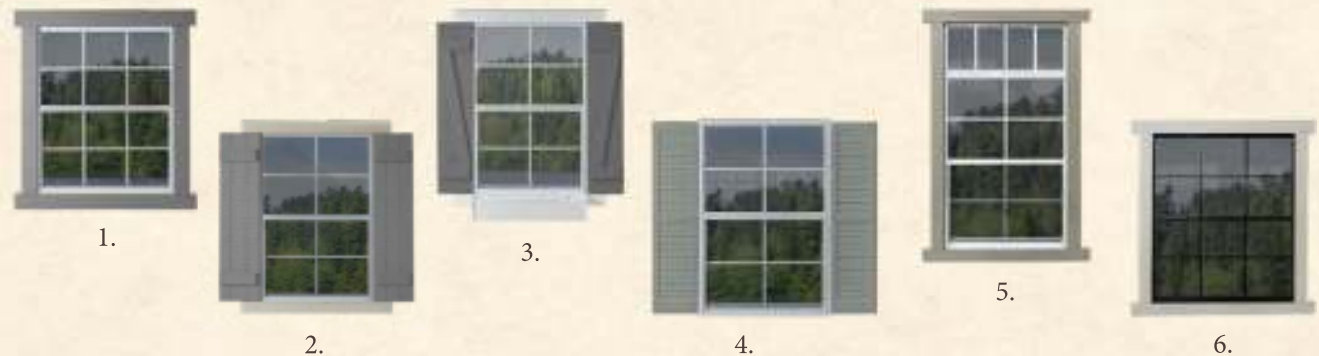

DOORS

- 1. Plain door
- 2. Diamond bottom (*standard*)
- 3. Decorative hinges (*standard on EZ-Fit Series*)
- 4. Decorative hinges and transom windows
- 5. Plain Door with 24x24" windows
- 6. Fiberglass with transom windows
- 7. Entrance door with glass
- 8. Entrance door 6 panel



Due to variables in the printing process, color samples may vary in color and sheen from the actual materials.

Restructure your backyard

Paint & Stain Options

STANDARD PAINT & TRIM COLORS

Painting is included with prebuilt structures & optional for built onsite structures.



Due to variables in the printing process, color samples may vary in color and sheen from the actual materials.





Driftwood Stain

Chestnut Brown with Buckskin Trim

URETHANE STAINS

Enjoy the beauty of a semi-transparent stain coupled with the durability of Smartside siding. Also includes painted trim.



Rustic Cedar



Chestnut Brown



Driftwood

POPULAR OPTIONS

Here's some of our favorite color schemes!

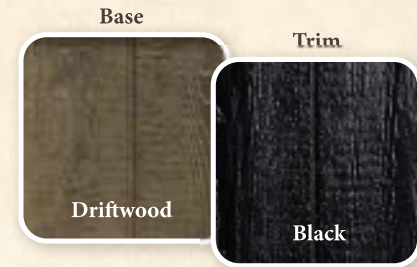

STAIN

Due to variables in the printing process, color samples may vary in color and sheen from the actual materials.

Options & Accessories

MISCELLANEOUS OPTIONS

1. Treated ramp 48", 60", or 72" width
2. Steps and railing
3. Steps with landing
4. 4' Treated deck
5. Shelving
6. Loft Ladder



CUPOLAS & WEATHERVANES

1. Cupolas: painted white, 16" or 22"
2. 16" Painted cupola with weathervane
3. Eagle weathervane
4. Rooster weathervane
5. Horse weathervane

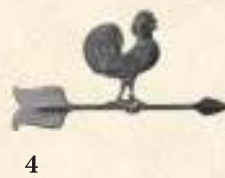

MISCELLANEOUS OPTIONS

1. Awning roof
2. Post "Y" braces
3. Single or double door threshold
4. Decorative flowerbox holder
5. 12" Decorative hinges *Std. on EZ-Fit Series*

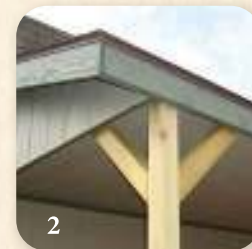

Built On-Site Structures

- Available in any size building
- Onsite construction eliminates access problems
- Prefabricated panels & trusses are built in our facility
- Optional Painting/Staining
Painted by our team before we deliver!



Built on-site structures are prefabricated in our facility and assembled on the job-site, allowing us to build your shed right on the spot. Painting is optional.



Prebuilt Structures

- Available in smaller sheds
(contact salesman for size limitations)
- Access needed to site
- Delivered fully assembled
- Includes Painting
(with Smartside Siding)
- Mule Delivery available upon request



Prebuilt structures are assembled in our facility and delivered to your site by truck and trailer. Painting is included on buildings with smartside siding.



Doors Back



Doors Passenger



Mule delivery



Alpine STRUCTURES

email sales@alpinestructures.net
phone 330.359.5708 • 800.359.7522

custom structures

custom built structures – modified to fulfill your expectations.



2675 US 62 · Dundee, Ohio 44624 | Located 1.5 miles West of Winesburg, Ohio | Contractor #PA039333, WV050269 | ©2023

